



### Model: CVR06FD Series Roller Conveyor Oven

LEWCO Conveyor Ovens offer higher throughput compared to batch ovens, resulting in labor savings through increased material handling efficiency. These ovens are suitable for a variety of applications such as heat-treating, curing and drying. Roller conveyor ovens sometimes referred to as roller bed ovens have the heaviest load capacity. A series of rollers, mounted in bearings with sprockets on one end are driven by a common drive chain (or series of chain loops) connected to a gear motor. This conveyor design can also provide zoned accumulation, allowing product to accumulate inside the oven. All LEWCO Conveyor Ovens are manufactured to meet the requirements of NFPA 86.

#### Operating Temperature

- 200°F - 650°F (93°C - 343°C)

#### Heat Source

- Direct fired natural gas, modulating burner with direct coupled, digital actuated control valve provides visual indications of valve position.
- High turndown ration allows rapid heat-up and tight temperature control.
- Low CO and NOX emissions
- F.M. compliant fuel train

#### Airflow Pattern

- Dual (combination) Airflow: Hot air is supplied from both of the side walls and returned through a top plenum.

#### General Construction

- 16 ga. aluminized inner shell
- 18 ga. C.R.S. exterior
- Optional: stainless steel
- Heat loss is minimized by a proprietary wall design featuring a welded inner shell and a completely isolated outer frame and covers.

#### Workspace Sizes

- **Heights:** 12" - 36"
- **Widths:** 24" - 60"
- **Lengths:** 96" - 360"

#### Controls

- Variable speed conveyor drive(s) can be operated in either continuous or timed index mode.
  - Variable speed: 0.50 – 2.00 F.P.M. (feet per minute)
- Single set-point temperature controller and redundant high-limit controller.
- NEMA 12 enclosure with full voltage lockable disconnect switch.
- Fan(s) include air proving circuits that are electrically interlocked with the heating circuit.
- Controls are wired to NFPA 70 and 79 electrical standards and meet the requirements of NFPA 86, Class B ovens.
- Optional:
  - Chart Recorder
  - Data Logger
  - Zero Speed Switch for Fans
  - PLC
  - Touchscreen HMI

#### Electrical Requirements

- Voltage: 480/3/60
- Other voltages available

#### Conveyor Rollers

- 2 ½" dia. x 11 ga. Roller with welded sprockets
- Roll centers available at 4 ½" or 6"

#### Entrance/ Exit Openings

- Standard: Open with no covers
- Optional:
  - Strip curtains
  - Adjustable insulated plates
  - Pneumatic guillotine doors with door switch (requires compressed air at 60 PSI)

#### Finish

- Blue or gray alkyd enamel
- Optional: Premium finish for corrosive environments.

#### Additional Options

- NFPA 86 Class A rating
- Custom sizes and features available. Please consult a LEWCO Applications Engineer for more information.

#### Quality Assurance

- Each unit comes complete with a (1) year warranty and is fully assembled, wired, and tested prior to shipment.
- Unit manufactured under ISO 9001 Certification.

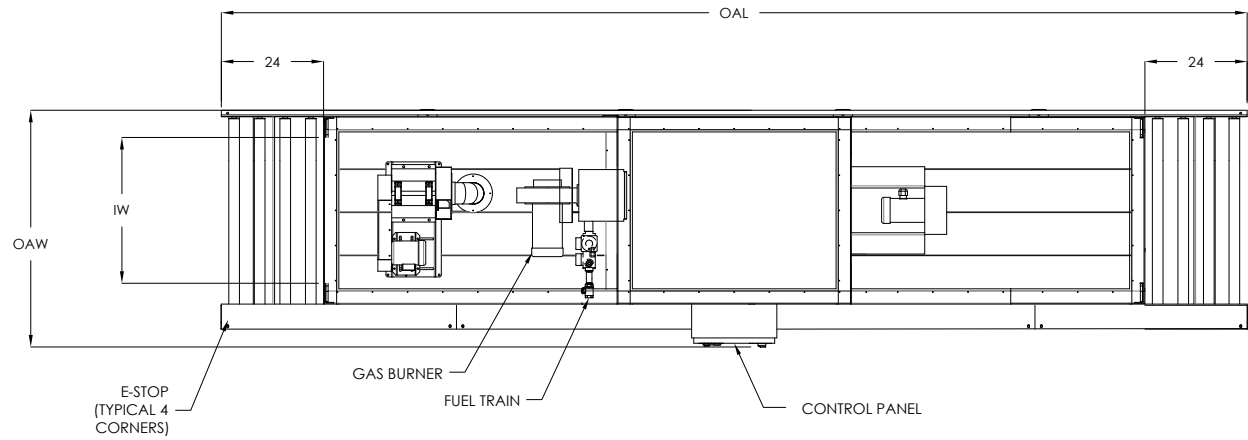

PLAN VIEW

CONVEYOR TRAVEL →

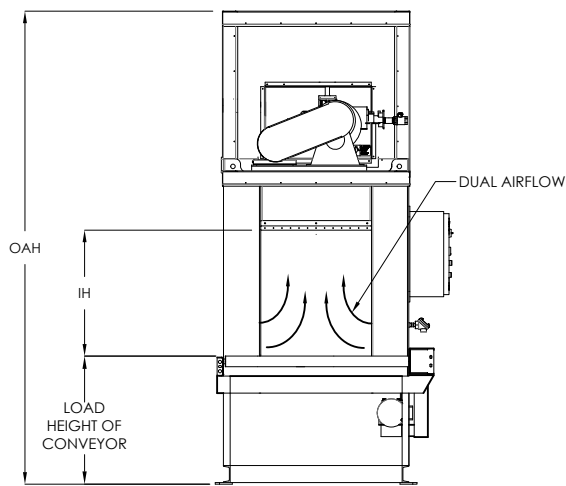

INFEED END ELEVATION

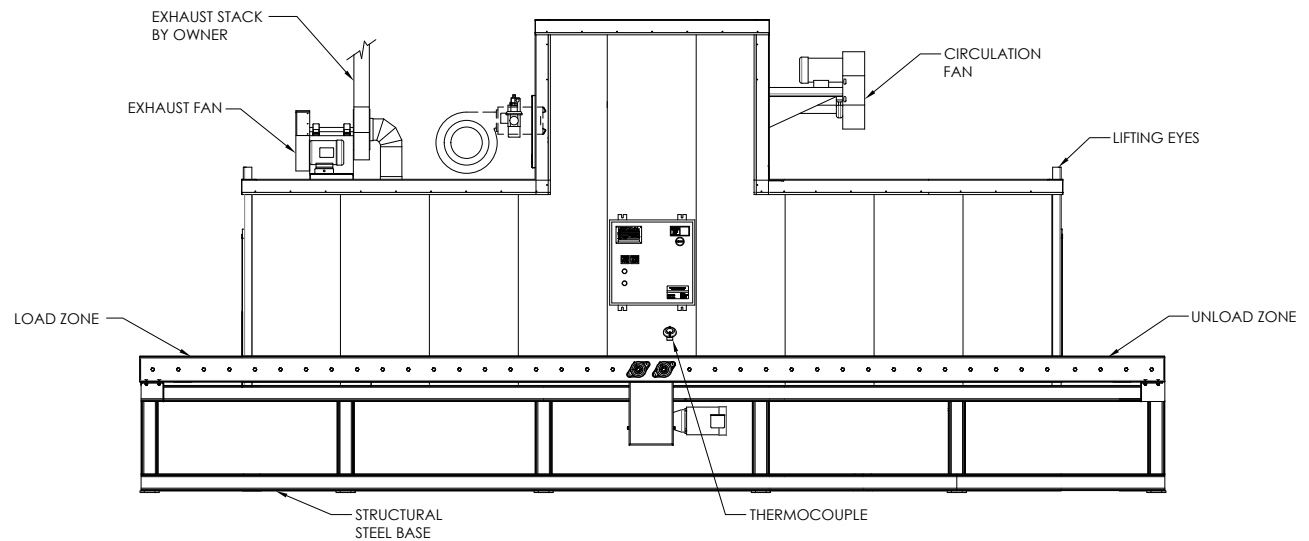

RIGHT SIDE ELEVATION

THE NATIONAL FIRE PROTECTION ASSOCIATION'S STANDARD NFPA 86 DOCUMENTS GUIDELINES FOR THE SAFE OPERATION OF OVENS AND FURNACES. THIS STANDARD DEFINES AN OVEN OCCASIONED BY THE PRESENCE OF FLAMMABLE VOLATILES OR COMBUSTIBLE MATERIAL AS "CLASS A" AND FURTHER MANDATES SPECIFIC SAFETY EQUIPMENT ON THESE OVENS TO REDUCE THE RISK OF FIRE OR EXPLOSION. SIMILARLY, OVENS OR FURNACES WHEREIN NO FLAMMABLE VOLATILES OR COMBUSTIBLE MATERIALS ARE PRESENT ARE CONSIDERED "CLASS B". IT IS IMPERATIVE THAT THE USER OF HEAT PROCESSING EQUIPMENT BE KNOWLEDGEABLE REGARDING APPLICATION OF THE EQUIPMENT.

MODEL: CVR\*\*FD  
 DESCRIPTION: Chain Roller Conveyor Oven, Top Heater, Fuel Fired, Dual Air Flow  
 DRAWING: CVRFD SALES

THIS DRAWING IS CONFIDENTIAL AND MUST NOT BE COPIED, REPRODUCED OR USED FOR ANY PURPOSE WITHOUT THE WRITTEN CONSENT OF LEWCO, INC. ALL RIGHTS RESERVED

LEWCO, INC. IS COMMITTED TO CONTINUOUS IMPROVEMENT AND RESERVES THE RIGHT TO CHANGE DESIGNS AND SPECIFICATIONS WITHOUT NOTICE.

DATE 8/5/14  
 REV 000  
 PAGE 1 OF 1

