



Model: EWR05ED

Enhanced Duty Walk-In Oven

LEWCO Enhanced-Duty Batch Ovens are designed for critical applications, such as those in the advanced materials and aerospace industries. These models offer all of the same construction features as the Normal-Duty ovens; however the performance is "enhanced" by adding additional heat capacity and larger circulation fans. Enhanced-Duty ovens also guarantee a temperature uniformity of at least +/- 10°F. The EWR Series features a rear mounted heater box, which is ideal for installations with height restrictions. Each unit is fully assembled, wired, and tested prior to shipment. All LEWCO ovens are manufactured to meet the requirements of NFPA 86.

Operating Temperature

- 150°F - 500°F (66°C -260°C)

Heating Source & Capacity

- Electric, low watt density Incoloy® heaters provide years of trouble free service.
- Standard heater bank assemblies are installed in high velocity ductwork to maximize heat transfer.

Airflow Pattern

- Dual Airflow: Hot air is supplied from both of the side walls and returned through a top plenum.

General Construction

- 16 ga. aluminized steel interior
- 18 ga. cold rolled steel exterior
- Heat loss is minimized by a unique wall design featuring a welded inner shell and a completely isolated outer frame and covers.

Finish

- Blue or gray alkyd enamel
- Optional: Premium finish for corrosive environments

Doors

- Heavy-duty doors on an isolated door frame minimize heat loss. Wire core gaskets create a tight seal for efficient heating.
- Explosion venting latches
- Standard: Bi-parting swing doors
- Optional:
 - Vertical lift guillotine door
 - Door windows

Floor

- Standard: 12 ga. plate floor
- Optional:
 - 12 ga. plate floor with (1) pair inverted angle track
 - 12 ga. plate floor with (1) pair 6" wide wheel guides
 - Insulated (100 p.s.f. max.)
 - Insulated with (1) pair inverted angle track
 - Insulated with (1) pair 6" wide wheel guides
 - No floor

Input Voltage

- Standard 480/3/60
- Please consult factory for other available options.

Controls

- Single set-point temperature controller and redundant high-limit controller
- NEMA 12 enclosure with full voltage lockable disconnect switch
- Circulation fan(s) include air proving circuits that are electrically interlocked with the heating circuit.
- Controls are wired to NFPA 70 and 79 electrical standards, and meet the requirements of NFPA 86, Class B ovens.
- Optional:
 - Door Switch
 - Batch Timer
 - Ramp/ Soak controller
 - Data logger/ chart recorder
 - Zero speed switch for fans
 - Composite curing controls

Quality Assurance

- Each unit comes complete with a (1) year warranty and is fully assembled, wired, and tested prior to shipment.
- Unit manufactured under ISO 9001 Quality Certified System.



Industrial Batch Ovens

Model: EWR05ED

Model (NFPA Class B)	Overall Dimensions			Door Swing Radius	Workspace Dimensions			Heater Bank (kW)	Circulating Fan (CFM)	Motor (HP)	Air Changes per Minute	Exhaust Fan Capacity (CFM)	Exhaust Motor (HP)	Solvents per Batch (Gals.)	Ships Fully Assembled
	"W	"D	"H		"W	"D	"H								
EWR05ED-48-48-60	79	106	72	24"	48	48	60	45	1,700	1	21.25	N/A	N/A	0	Yes
EWR05ED-48-48-72	81	106	84	24"	48	48	72	45	2,000	1 1/2	20.83	N/A	N/A	0	Yes
EWR05ED-48-48-96	83	106	108	24"	48	48	96	54	2,500	2	19.53	N/A	N/A	0	Yes
EWR05ED-48-72-72	83	134	84	24"	48	72	72	54	3,000	2	20.83	N/A	N/A	0	Yes
EWR05ED-48-72-96	85	140	108	24"	48	72	96	63	4,000	3	20.83	N/A	N/A	0	Yes
EWR05ED-48-96-72	85	164	84	24"	48	96	72	63	4,000	3	20.83	N/A	N/A	0	Yes
EWR05ED-48-96-96	89	168	108	24"	48	96	96	72	5,000	3	19.53	N/A	N/A	0	Yes
EWR05ED-60-60-60	95	118	72	30"	60	60	60	45	2,500	2	20.00	N/A	N/A	0	Yes
EWR05ED-60-60-72	95	122	84	30"	60	60	72	54	3,000	2	20.00	N/A	N/A	0	Yes
EWR05ED-60-60-96	97	128	108	30"	60	60	96	63	4,000	3	20.00	N/A	N/A	0	Yes
EWR05ED-60-72-72	97	134	84	30"	60	72	72	54	3,500	3	19.44	N/A	N/A	0	Yes
EWR05ED-60-72-96	99	144	108	30"	60	72	96	63	4,500	3	18.75	N/A	N/A	0	Yes
EWR05ED-60-96-96	103	174	108	30"	60	96	96	72	6,000	3	18.75	N/A	N/A	0	Yes
EWR05ED-72-72-72	109	140	84	36"	72	72	72	63	4,000	3	18.52	N/A	N/A	0	Yes
EWR05ED-72-72-96	113	150	108	36"	72	72	96	72	5,500	3	19.10	N/A	N/A	0	Yes
EWR05ED-72-96-96	121	174	108	36"	72	96	96	81	8,000	5	20.83	N/A	N/A	0	Yes
EWR05ED-72-120-96	125	198	108	36"	72	120	96	90	9,000	7 1/2	18.75	N/A	N/A	0	Yes
EWR05ED-84-84-84	129	162	96	42"	84	84	84	72	7,000	5	20.41	N/A	N/A	0	Yes
EWR05ED-84-96-84	133	174	96	42"	84	96	84	81	8,000	5	20.41	N/A	N/A	0	Yes
EWR05ED-84-120-84	137	205	96	42"	84	120	84	90	10,000	7 1/2	20.41	N/A	N/A	0	Yes
EWR05ED-84-120-96	141	210	108	42"	84	120	96	99	12,000	7 1/2	21.43	N/A	N/A	0	Yes
EWR05ED-96-96-96	149	181	108	48"	96	96	96	90	10,000	7 1/2	19.53	N/A	N/A	0	Yes
EWR05ED-96-120-96	153	210	108	48"	96	120	96	108	12,000	7 1/2	18.75	N/A	N/A	0	Yes
EWR05ED-96-144-96	161	243	108	48"	96	144	96	117	16,000	10	20.83	N/A	N/A	0	Yes
EWR05ED-96-168-96	167	267	108	48"	96	168	96	144	18,000	15	20.09	N/A	N/A	0	Yes
EWR05ED-120-120-96	185	219	108	60"	120	120	96	117	16,000	10	20.00	N/A	N/A	0	Yes
EWR05ED-120-120-120	193	224	132	60"	120	120	120	153	20,000	15	20.00	N/A	N/A	0	Yes
EWR05ED-120-144-96	191	243	108	60"	120	144	96	153	18,000	15	18.75	N/A	N/A	0	Yes
EWR05ED-120-144-120	197	218	132	60"	120	144	120	162	24,000	15	20.00	N/A	N/A	0	Yes
EWR05ED-120-168-96	193	242	108	60"	120	168	96	162	22,000	15	19.64	N/A	N/A	0	Yes
EWR05ED-120-168-120	203	242	132	60"	120	168	120	180	26,000	15	18.57	N/A	N/A	0	Yes

NOTE: Sizes are approximate. LEWCO, Inc. reserves the right to change specifications without notice.



Industrial Batch Ovens

Model: EWR05ED

Model (NFPA Class A)	Overall Dimensions			Door Swing Radius	Workspace Dimensions			Heater Bank (kW)	Circulating Fan (CFM)	Motor (HP)	Air Changes per Minute	Exhaust Fan Capacity (CFM)	Exhaust Motor (HP)	Solvents per Batch (Gals.)	Ships Fully Assembled
	"W	"D	"H		"W	"D	"H								
EWR05ED-48-48-60	79	106	123	24"	48	48	60	54	1,700	1	21.25	62	1/4	0.05	Yes
EWR05ED-48-48-72	81	106	135	24"	48	48	72	54	2,000	1 1/2	20.83	62	1/4	0.05	Yes
EWR05ED-48-48-96	83	106	159	24"	48	48	96	63	2,500	2	19.53	62	1/4	0.05	No
EWR05ED-48-72-72	83	134	135	24"	48	72	72	63	3,000	2	20.83	62	1/4	0.05	Yes
EWR05ED-48-72-96	85	140	159	24"	48	72	96	63	4,000	3	20.83	62	1/4	0.05	No
EWR05ED-48-96-72	85	164	135	24"	48	96	72	63	4,000	3	20.83	62	1/4	0.05	Yes
EWR05ED-48-96-96	89	168	159	24"	48	96	96	72	5,000	3	19.53	62	1/4	0.05	No
EWR05ED-60-60-60	95	118	123	30"	60	60	60	54	2,500	2	20.00	62	1/4	0.05	Yes
EWR05ED-60-60-72	95	122	135	30"	60	60	72	63	3,000	2	20.00	62	1/4	0.05	Yes
EWR05ED-60-60-96	97	128	159	30"	60	60	96	72	4,000	3	20.00	62	1/4	0.05	No
EWR05ED-60-72-72	97	134	135	30"	60	72	72	63	3,500	3	19.44	62	1/4	0.05	Yes
EWR05ED-60-72-96	99	144	159	30"	60	72	96	72	4,500	3	18.75	62	1/4	0.05	No
EWR05ED-60-96-96	103	174	159	30"	60	96	96	90	6,000	3	18.75	100	1/4	0.08	No
EWR05ED-72-72-72	109	140	135	36"	72	72	72	72	4,000	3	18.52	62	1/4	0.05	Yes
EWR05ED-72-72-96	113	150	159	36"	72	72	96	81	5,500	3	19.10	62	1/4	0.05	No
EWR05ED-72-96-96	121	174	159	36"	72	96	96	99	8,000	5	20.83	100	1/4	0.08	No
EWR05ED-72-120-96	125	198	159	36"	72	120	96	108	9,000	7 1/2	18.75	100	1/4	0.08	No
EWR05ED-84-84-84	129	162	147	42"	84	84	84	99	7,000	5	20.41	100	1/4	0.08	No
EWR05ED-84-96-84	133	174	147	42"	84	96	84	99	8,000	5	20.41	100	1/4	0.08	No
EWR05ED-84-120-84	137	205	147	42"	84	120	84	153	10,000	7 1/2	20.41	250	1/4	0.21	No
EWR05ED-84-120-96	141	210	159	42"	84	120	96	153	12,000	7 1/2	21.43	250	1/4	0.21	No
EWR05ED-96-96-96	149	181	159	48"	96	96	96	153	10,000	7 1/2	19.53	250	1/4	0.21	No
EWR05ED-96-120-96	153	210	159	48"	96	120	96	162	12,000	7 1/2	18.75	250	1/4	0.21	No
EWR05ED-96-144-96	161	243	159	48"	96	144	96	171	16,000	10	20.83	250	1/4	0.21	No
EWR05ED-96-168-96	167	267	159	48"	96	168	96	189	18,000	15	20.09	250	1/4	0.21	No
EWR05ED-120-120-96	185	219	159	60"	120	120	96	180	16,000	10	20.00	250	1/4	0.21	No
EWR05ED-120-120-120	193	224	183	60"	120	120	120	189	20,000	15	20.00	250	1/4	0.21	No
EWR05ED-120-144-96	191	243	159	60"	120	144	96	189	18,000	15	18.75	250	1/4	0.21	No
EWR05ED-120-144-120	197	218	183	60"	120	144	120	207	24,000	15	20.00	250	1/4	0.21	No
EWR05ED-120-168-96	193	242	159	60"	120	168	96	198	22,000	15	19.64	250	1/4	0.21	No
EWR05ED-120-168-120	203	242	183	60"	120	168	120	225	26,000	15	18.57	500	1	0.42	No

NOTE: Sizes are approximate. LEWCO, Inc. reserves the right to change specifications without notice.

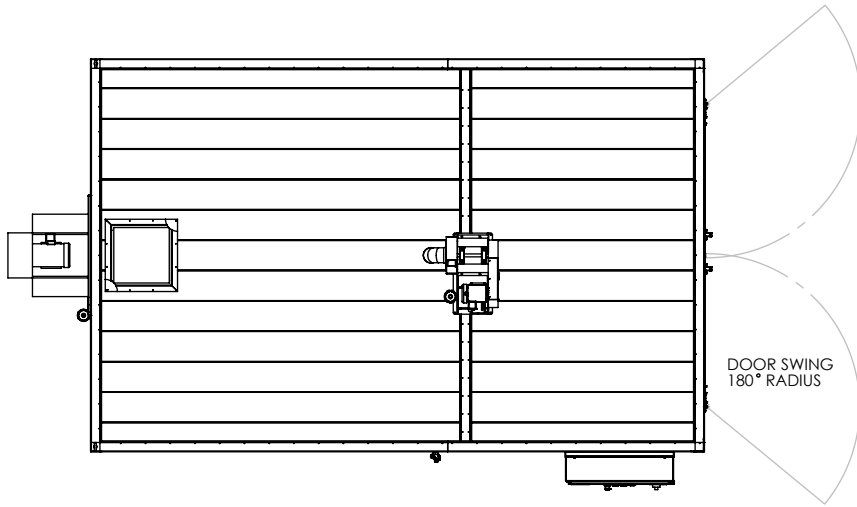

PLAN VIEW

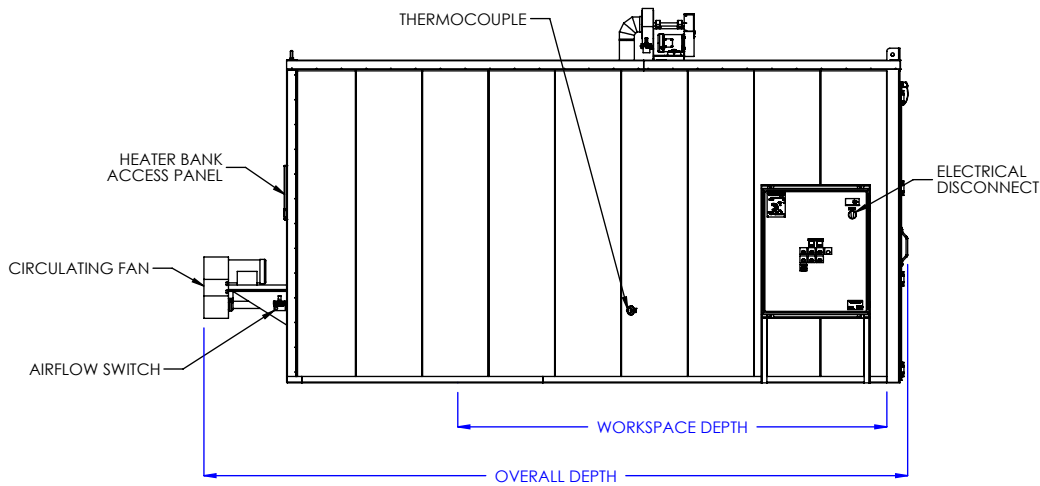

LEFT SIDE ELEVATION

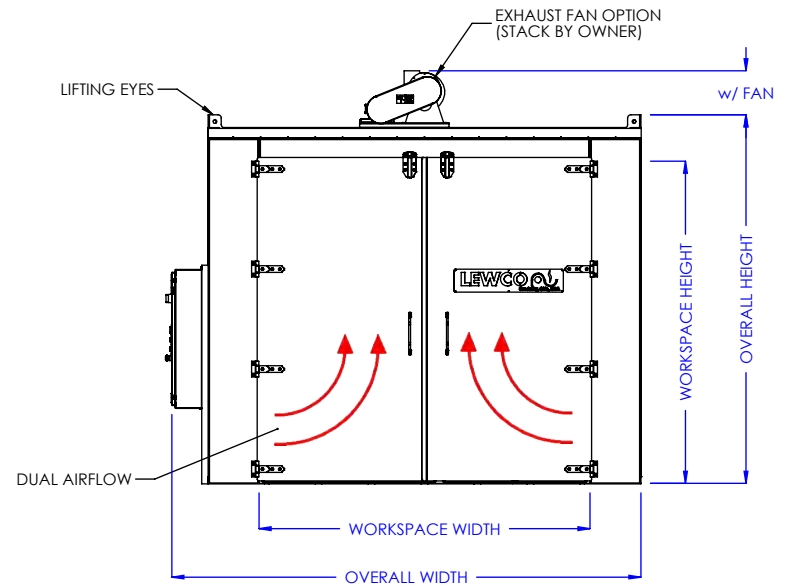

FRONT ELEVATION

MODEL: EWR05ED

DESCRIPTION: ENHANCED DUTY WALK-IN OVEN, REAR MOUNT HEATER,
500° F, ELECTRIC, DUAL AIRFLOW

WARNING: OVENS PROCESSING FLAMMABLE VOLATILES OR COMBUSTIBLE MATERIALS ARE CLASSIFIED BY NFPA 86 AS "CLASS A" OVENS AND REQUIRE SPECIFIC SAFETY FEATURES. KNOW THE PROPERTIES OF THE MATERIALS BEING HEATED. EXPLOSION OR FIRE MAY RESULT FROM MISAPPLICATION.

LEWCO, INC. IS COMMITTED TO CONTINUOUS IMPROVEMENT AND RESERVES THE RIGHT TO CHANGE DESIGNS AND SPECIFICATIONS WITHOUT NOTICE.

THIS DRAWING MUST NOT BE COPIED, REPRODUCED OR USED FOR ANY PURPOSE WITHOUT THE WRITTEN CONSENT OF LEWCO, INC. ALL RIGHTS RESERVED.

DATE: 10/9/2017

REV. 001

PAGE: 1 of 1

LEWCO

706 LANE ST. SANDUSKY, OH 44870, U.S.A.