



Low Profile

Model: EC02L (2) Drum Hot Box, Electric

LEWCO's drum heating product line offers standard cost-effective solutions for melting, viscosity reduction, elevated temperature storage and general industrial heating applications. The Low Profile design allows for convenient loading with a pallet jack or drum dolly. All models feature our signature heavy-duty welded construction and simple, user-friendly controls. This model is not suitable for heating flammable or combustible materials, or for installation in electrically hazardous locations. Consult factory for non-standard safety features required for compliance with NFPA 86.

Capacity

- (2) 55-gallon drums palletized
- 1,350 lbs. per pallet

Operating Temperature

- 125°F - 300°F
- Consult factory for applications below 125°F

Construction/ Features

- Welded, 1/8" steel shell
- Optional: Stainless steel
- 12 ga. plate steel floor
- Insulation: 3" x 6# mineral wool
- Heavy duty doors with strap hinges, 2-point latch system, and high-temperature silicone rubber gaskets create a tight seal for efficient heating.
- Interior door release for safety

Finish

- Blue or gray alkyd enamel
- Optional: Premium finish for corrosive environments.

Heat Source & Capacity

- Electric, low watt density Incoloy® heaters provide years of trouble-free service.
- 6 kW

Controls

- Single set-point temperature controller and redundant high-limit controller.
- NEMA 12 enclosure with full voltage lockable disconnect switch.
- Controls are wired to NFPA 70 and 79 electrical standards.
- Optional:
 - Batch Timer
 - Data Logger
 - Door Switch

Electrical Requirements

- Voltage: 480/3/60
- Disconnect: 30 amps
- Other voltages available

Shipping & Installation

- Ships completely assembled for easy installation.
- Shipping weight: 1,200 lbs.
- Suitable for indoor use only.

Additional Options

- Circulating Fan: 330 CFM, TEFC motor with motor starter
- 5" exhaust vent with damper
- UL or CSA Certification
- Custom sizes and features available. Please consult a LEWCO Applications Engineer for more information.

Quality Assurance

- Each unit comes complete with a (3) year warranty and is fully assembled, wired, and tested prior to shipment.

* INDICATES OPTIONAL FEATURE

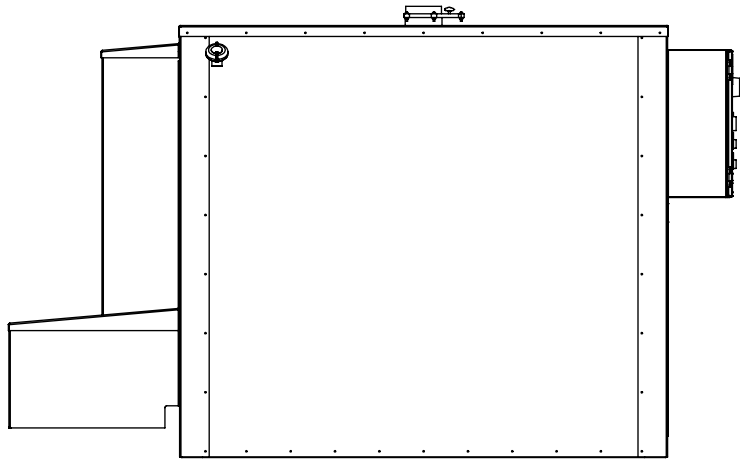

REAR ELEVATION

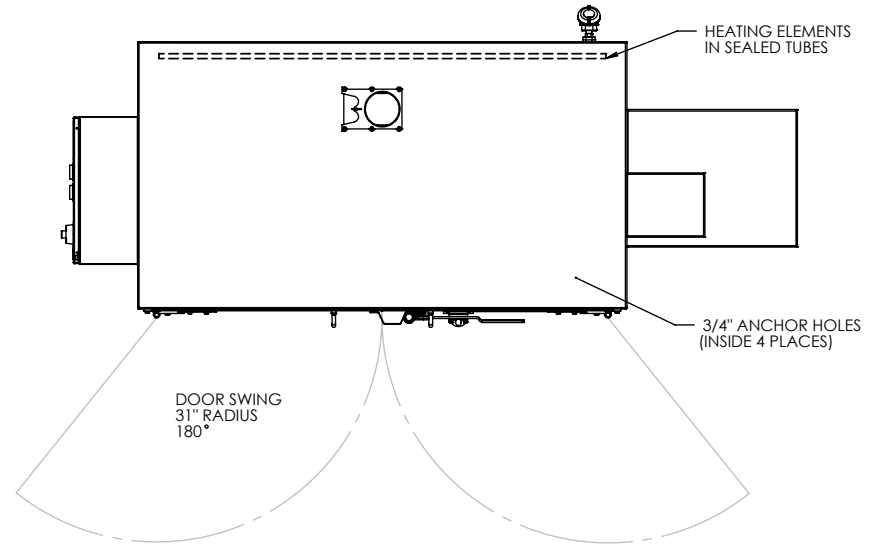

PLAN VIEW

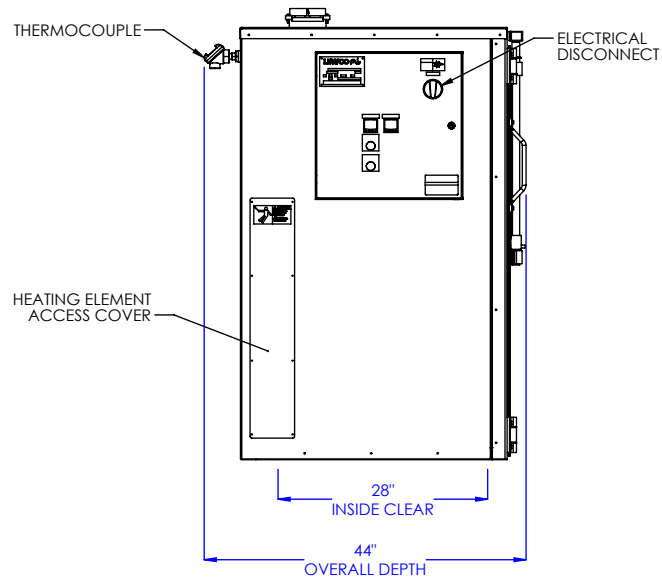

LEFT SIDE ELEVATION

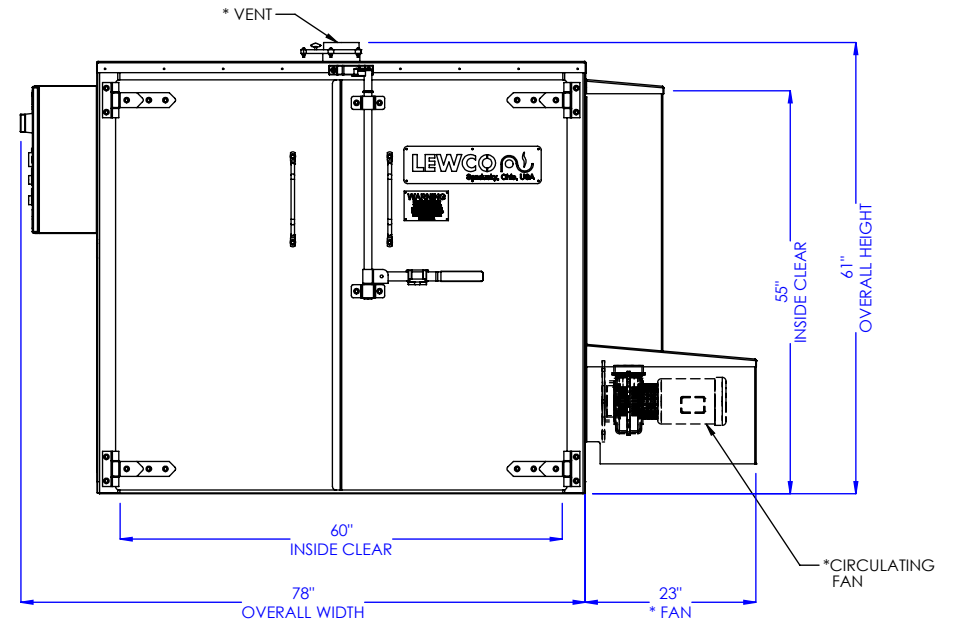

FRONT ELEVATION

MODEL: EC02L

DESCRIPTION: ELECTRIC HEATING CABINET, 2 DRUM, LOW PROFILE

DANGER: ELECTRIC HOT BOXES ARE NOT SUITABLE FOR HEATING FLAMMABLE OR COMBUSTIBLE MATERIALS; NOR FOR INSTALLATION IN ELECTRICALLY CLASSIFIED AREAS.

LEWCO, INC. IS COMMITTED TO CONTINUOUS IMPROVEMENT AND RESERVES THE RIGHT TO CHANGE DESIGNS AND SPECIFICATIONS WITHOUT NOTICE.

THIS DRAWING MUST NOT BE COPIED, REPRODUCED OR USED FOR ANY PURPOSE WITHOUT THE WRITTEN CONSENT OF LEWCO, INC. ALL RIGHTS RESERVED.

DATE: 9/16/2016

REV. 001

PAGE: 1 of 1



706 LANE ST. SANDUSKY, OH 44870, U.S.A.