



Standard Profile

Model: HEC12S

(12) Drum High-Performance Oven, Electric

LEWCO High-Performance Drum & Tote Ovens provide 25% faster heat-up times and, by design, are safer than traditional Hot Boxes. These models employ a high-velocity fan, which pulls air from the oven workspace, circulates it over the heating elements, and then delivers it at a highly convective rate back to the oven workspace. The Standard Profile design features an insulated base with spill containment sump. As standard, High-Performance Ovens are designed and manufactured to meet the requirements of NFPA 86, Class B ovens. This model is not suitable for applications involving the off-gassing of flammable volatiles, or for installation in electrically hazardous locations. Consult factory for non-standard features required for compliance with NFPA 86, Class A ovens.

Capacity

- (12) 55-gallon drums palletized
- 2,700 lbs. per pallet

Operating Temperature

- 125°F - 300°F
- Optional: 450°F
- Consult factory for applications below 125°F

Construction/ Features

- Welded, 1/8" steel shell
- Optional: Stainless steel
- Insulation: 4" x 6# mineral wool
- Heavy duty doors with strap hinges, 3-point latch system, and high-temperature silicone rubber gaskets create a tight seal for efficient heating.
- Interior door release for safety

Spill Containment

- 281 gallon capacity
- Sump drain 1" NPT

Finish

- Blue or gray alkyd enamel
- Optional: Premium finish for corrosive environments.

Heat Source & Capacity

- Electric, low watt density Incoloy® heaters provide years of trouble-free service.
- 54 kW

Circulating Fan

- 2,500 CFM, 2 HP. TEFC motor

Controls

- Single set-point temperature controller and redundant high-limit controller.
- NEMA 12 enclosure with full voltage lockable disconnect switch.
- Circulation fan(s) include air proving circuits that are electrically interlocked with the heating circuit.
- Controls are wired to NFPA 70 and 79 electrical standards, and meet the requirements of NFPA 86, Class B ovens.
- Optional:
 - Batch Timer
 - Data Logger
 - Door Switch
 - Ramp/ Soak Controller

Electrical Requirements

- Voltage: 480/3/60
- Disconnect: 100 amps
- Other voltages available

Shipping & Installation

- Ships completely assembled.
- Shipping weight: 6,500 lbs.
- Suitable for indoor use only.

Additional Options

- Exhaust Fan: 250 CFM, ¼ HP. TEFC motor
- NFPA 86 Class A rating
- UL or CSA Certification
- Custom sizes and features available. Please consult a LEWCO Applications Engineer for more information.

Quality Assurance

- Each unit comes complete with a (3) year warranty and is fully assembled, wired, and tested prior to shipment.

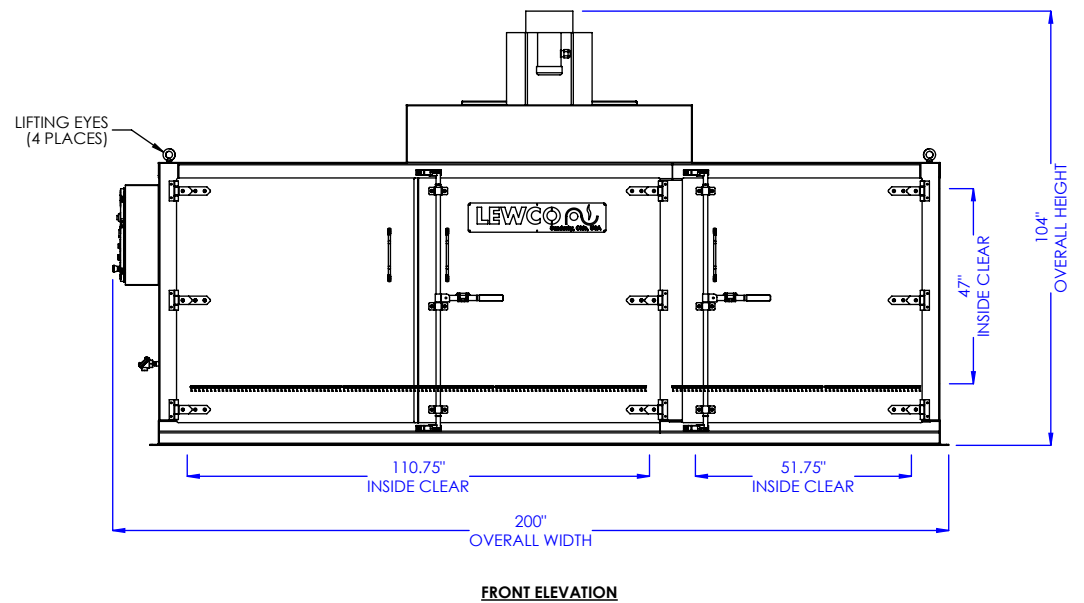
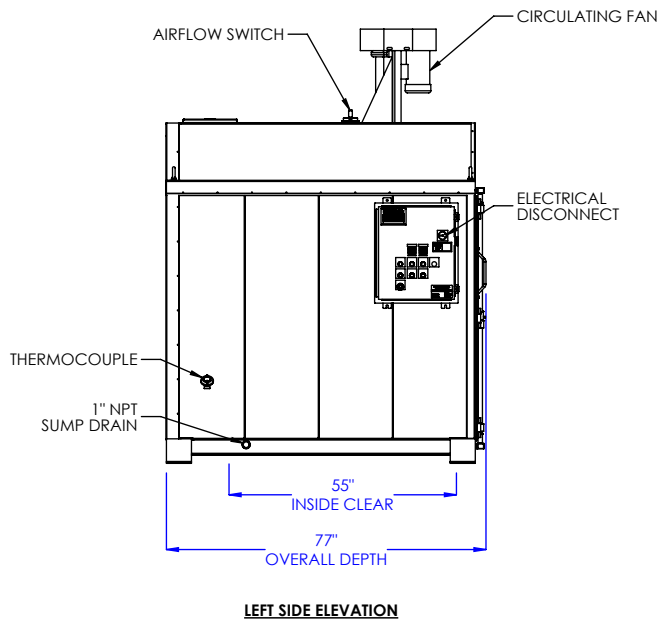
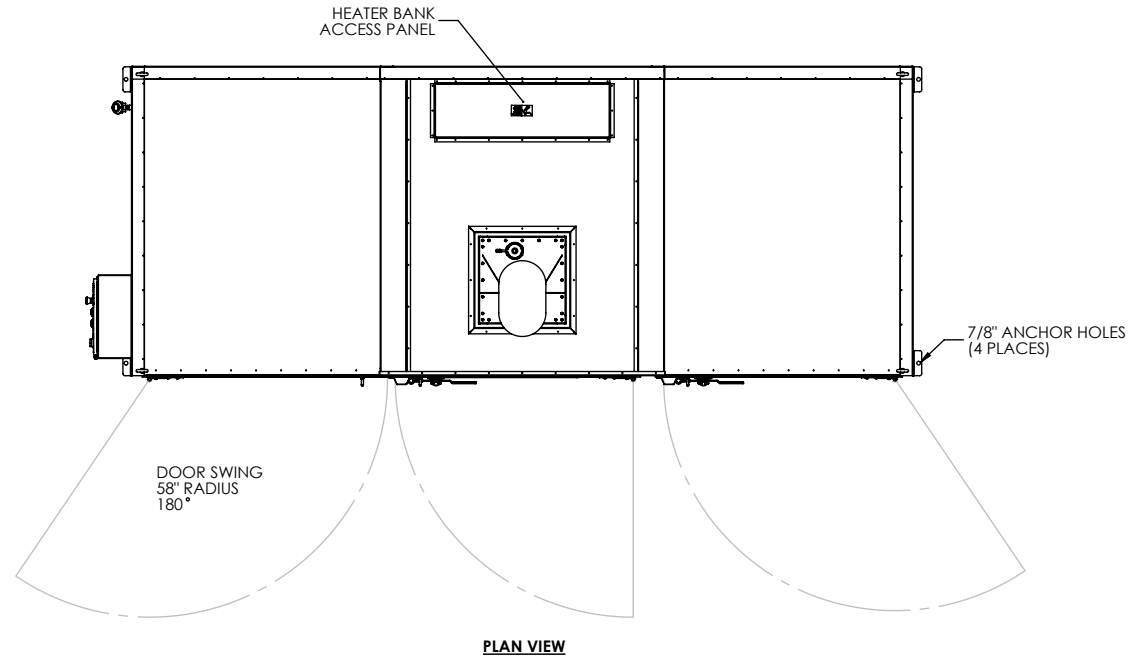

MODEL: HEC12S

DESCRIPTION: HIGH-PERFORMANCE ELECTRIC OVEN,
12 DRUM, STANDARD PROFILE

WARNING: OVENS PROCESSING FLAMMABLE VOLATILES OR COMBUSTIBLE MATERIALS REQUIRE SPECIAL NON-STANDARD SAFETY FEATURES TO COMPLY WITH NFPA 86, "CLASS A" OVENS. KNOW THE PROPERTIES OF THE MATERIALS BEING HEATED. EXPLOSION OR FIRE MAY RESULT FROM MISAPPLICATION.

LEWCO, INC. IS COMMITTED TO CONTINUOUS IMPROVEMENT AND RESERVES THE RIGHT TO CHANGE DESIGNS AND SPECIFICATIONS WITHOUT NOTICE.

THIS DRAWING MUST NOT BE COPIED, REPRODUCED OR USED FOR ANY PURPOSE WITHOUT THE WRITTEN CONSENT OF LEWCO, INC. ALL RIGHTS RESERVED.

DATE: 1/2/2017

REV. 001

PAGE: 1 of 1

LEWCO

706 LANE ST. SANDUSKY, OH 44870, U.S.A.